

## PLATINUM SMART-HEAT™ GAS

---

The Platinum Smart-Heat™ Gas heater series spreads heat and comfort evenly in all areas, with a soft and soothing red glow. Built with pure premium materials and designed with elegance, there is no compromise on performance, reliability and beauty.



500 SERIES



300 SERIES

# SPECIFICATIONS

Reference the specification guide below to help you select the correct solution for your needs.

MODEL NUMBER	300 SERIES	500 SERIES
PRODUCT CODE	BH0110002-1   BH0110001-1	BH0110004-1   BH0110003-1
FUEL TYPE	LPG   NG	LPG   NG
COLOR	BLACK   STAINLESS	BLACK   STAINLESS
HEAT AREA	160FT	215FT
RATED CURRENT	110V/2A	110V/2A
MINIMUM FLOOR CLEARANCE	96"	96"
OUTPUT	23,600 BTU	39,800 BTU

## MOUNTING OPTIONS

CEILING MOUNT	✓	✓
WALL MOUNT	✓	✓
RECESSED   FLUSH MOUNT	-	-
CEILING POLE MOUNT	✓	✓
FREESTANDING	-	-

## CONTROL OPTIONS

ON   OFF	✓	✓
ON   OFF PRODUCT CODE	BH3130010-1	BH3130010-1
DIMMER	-	-
MASTER REMOTE	-	-

Measurements displayed within this document are minimum requirements for installation. Bromic takes no responsibility for incorrect or non-compliant installations. All measurement in this document are displayed in inches.

# DIMENSIONS

With a wide range of sizes available, find the ideal heater to suit your outdoor space.

## FRONT PROFILE

## + HEAT DEFLECTOR

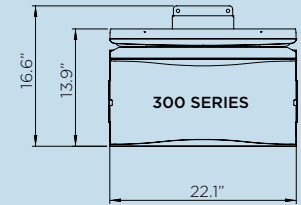
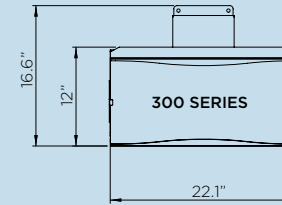
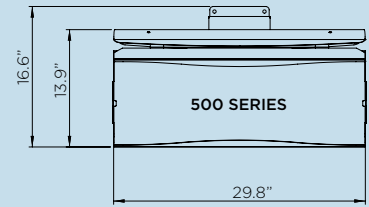
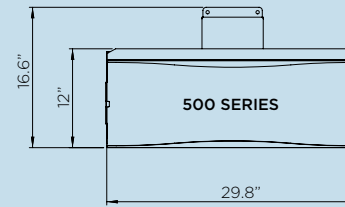

## SIDE PROFILE

## + HEAT DEFLECTOR

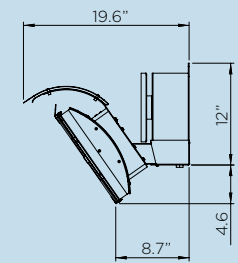
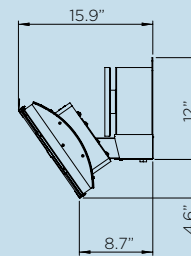

# MOUNT OPTIONS

With a wide array of mounting options, Bromic offers solutions to compliment any décor and provide functionality for ambiance and comfort.

## WALL MOUNT

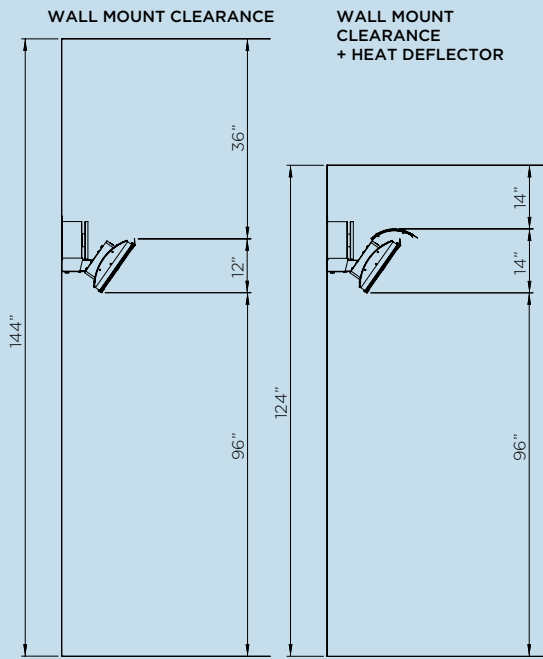

## CEILING MOUNT

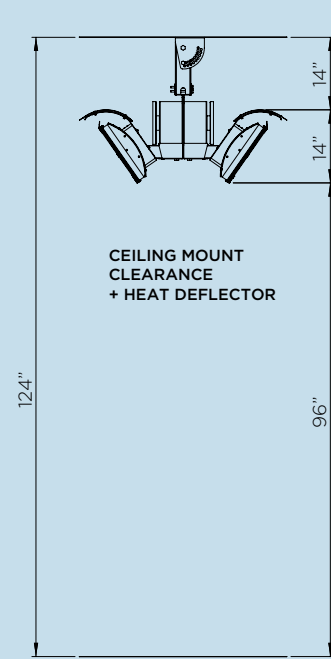

## WALL BRACKET

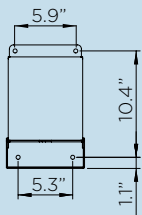

# HEATING REACH

Creating ideal comfort levels, Bromic heaters offer a variety of heat distribution options to suit your outdoor heating needs.

## 500 SERIES

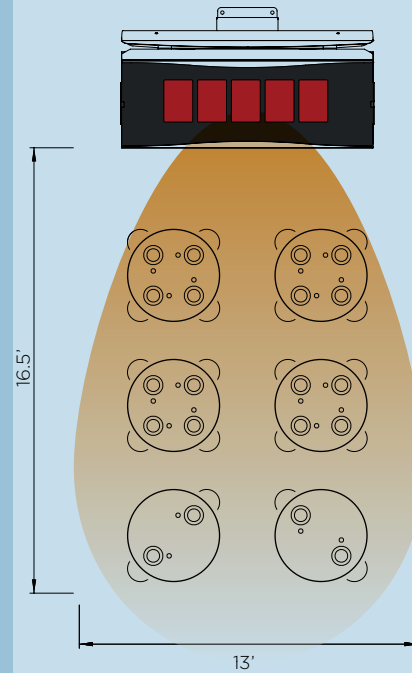

HEATING APPROXIMATELY 215FT<sup>2</sup>  
39,800 BTU HEATING POWER

## 300 SERIES

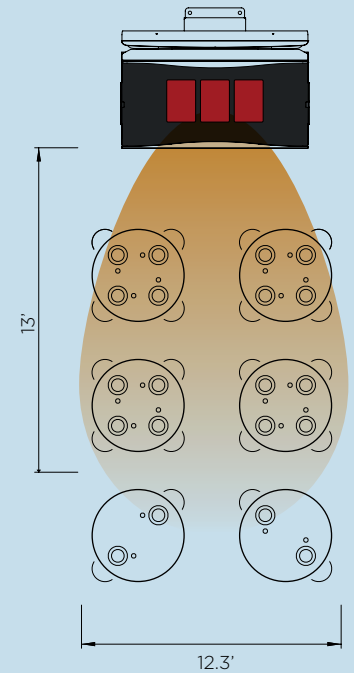

HEATING APPROXIMATELY 160FT<sup>2</sup>  
23,600 BTU HEATING POWER

## CONTROL OPTIONS



ON | OFF CONTROL



MASTER REMOTE



EXTEND YOUR COMFORT OUTDOORS  
WITH THE SUPERIOR HEAT AND  
AWARD-WINNING DESIGN OF OUR  
SMART-HEAT™ OUTDOOR HEATERS.

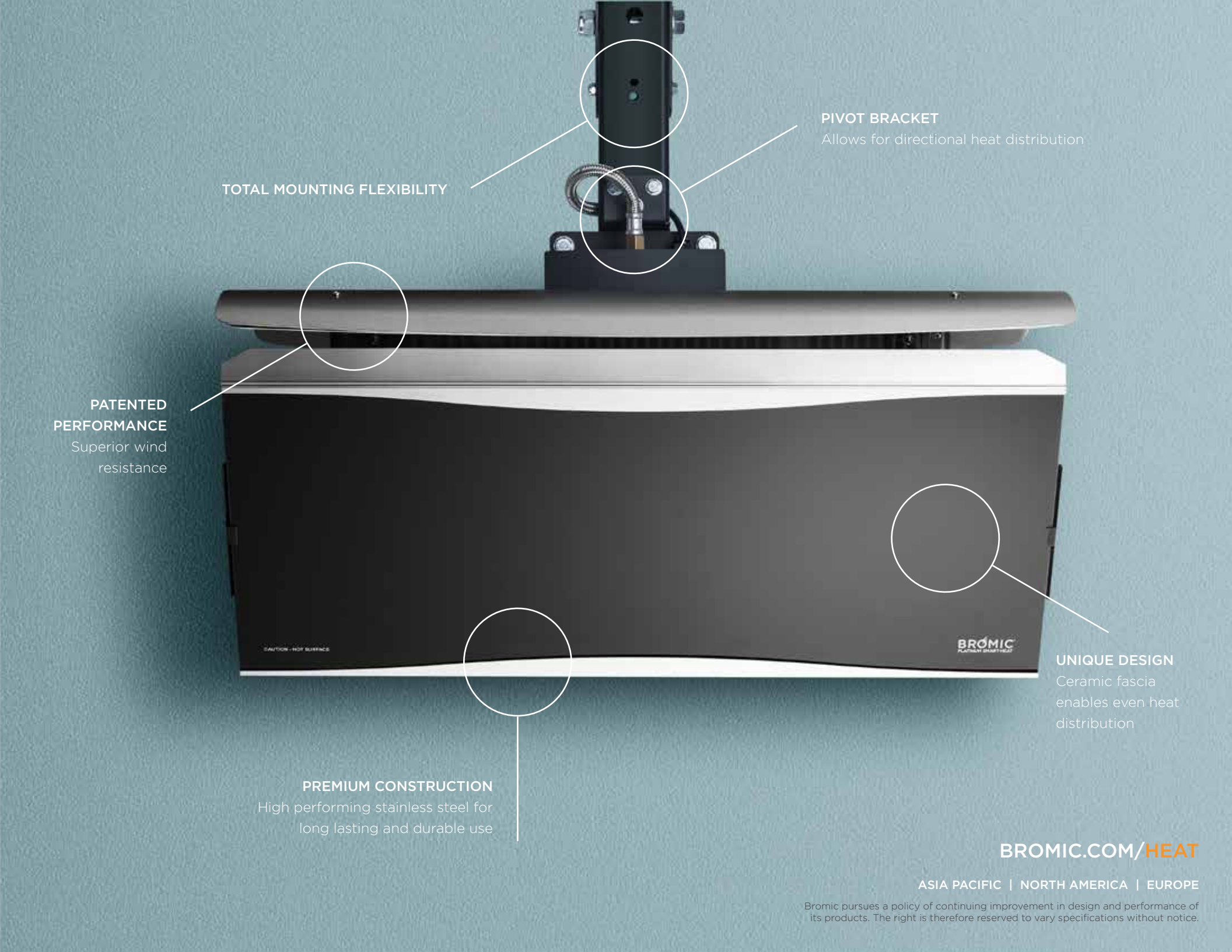

**PIVOT BRACKET**  
Allows for directional heat distribution

**TOTAL MOUNTING FLEXIBILITY**

**PATENTED PERFORMANCE**  
Superior wind resistance

**UNIQUE DESIGN**  
Ceramic fascia enables even heat distribution

**PREMIUM CONSTRUCTION**  
High performing stainless steel for long lasting and durable use

**BROMIC.COM/HEAT**

ASIA PACIFIC | NORTH AMERICA | EUROPE

Bromic pursues a policy of continuing improvement in design and performance of its products. The right is therefore reserved to vary specifications without notice.